

Ecotype diversity in the marine picoeukaryote *Ostreococcus* (Chlorophyta, Prasinophyceae)

Francisco Rodríguez,¹ Evelyne Derelle,² Laure Guillou,¹ Florence Le Gall,¹ Daniel Vaultot¹ and Hervé Moreau^{2*}

¹Station Biologique, UMR 7127 CNRS/INSU/UPMC, BP 74, 29682 Roscoff, France.

²Laboratoire Arago, UMR 7628 CNRS/UPMC, BP44, 66651, Banyuls-sur-mer, France.

Summary

The importance of the cyanobacteria *Prochlorococcus* and *Synechococcus* in marine ecosystems in terms of abundance and primary production can be partially explained by ecotypic differentiation. Despite the dominance of eukaryotes within photosynthetic picoplankton in many areas a similar differentiation has never been evidenced for these organisms. Here we report distinct genetic [rDNA 18S and internal transcribed spacer (ITS) sequencing], karyotypic (pulsed-field gel electrophoresis), phenotypic (pigment composition) and physiological (light-limited growth rates) traits in 12 *Ostreococcus* strains (Prasinophyceae) isolated from various marine environments and depths, which suggest that the concept of ecotype could also be valid for eukaryotes. Internal transcribed spacer phylogeny grouped together four deep strains isolated between 90 m and 120 m depth from different geographical origins. Three deep strains displayed larger chromosomal bands, different chromosome hybridization patterns, and an additional chlorophyll (chl) *c*-like pigment. Furthermore, growth rates of deep strains show severe photo-inhibition at high light intensities, while surface strains do not grow at the lowest light intensities. These features strongly suggest distinct adaptation to environmental conditions encountered at surface and the bottom of the oceanic euphotic zone, reminiscent of that described in prokaryotes.

Introduction

Picophytoplankton (cell diameter 0.2–2 µm) plays a

significant role in biogeochemical processes, primary productivity and food webs especially in oligotrophic areas, where it accounts typically for up to 80% of the autotrophic biomass (Campbell *et al.*, 1994; Li, 1994; Rocoap *et al.*, 2002). Over the past two decades, a large body of knowledge has accumulated on the diversity and ecophysiology of the cyanobacterium *Prochlorococcus* (Partensky *et al.*, 1999; Rocoap *et al.*, 2003). In particular, part of its global success has been attributed to the existence of distinct low- and high-light ecotypes, occupying different niches and exploiting different resources (Rocoap *et al.*, 2003).

Picoeukaryotic cells have been initially detected by their characteristic flow cytometry and pigment signatures over large geographical and vertical scales (Andersen *et al.*, 1996). However, the genetic and physiological traits that could explain their global distribution and ecological significance have not been well characterized to date. *Ostreococcus tauri* (Chrétiennot-Dinet *et al.*, 1995), the smallest (0.95 µm) free-living eukaryotic cell (Courties *et al.*, 1994), has been isolated from samples of various geographical and vertical origins (Díez *et al.*, 2001; Guillou *et al.*, 2004; Worden *et al.*, 2004). This organism belongs to the Prasinophyceae, a primitive class within the green plant lineage (Sym and Pienaar, 1993) globally reported as an abundant picoeukaryotic group throughout the oceanic euphotic zone (Sym and Pienaar, 1993; Díez *et al.*, 2001). The most striking features of *O. tauri* are its minimal cellular organization (Chrétiennot-Dinet *et al.*, 1995) (naked cell lacking flagella, with a single chloroplast and mitochondrion) and small genome (around 12 Mbp, currently being sequenced; Derelle *et al.*, 2002). These features and its phylogenetic position make of *Ostreococcus* a potentially powerful biological model to study fundamental cellular processes in photosynthetic eukaryotes.

Recent work has shown that small subunit (SSU) rDNA sequences of *Ostreococcus* from cultures and environmental samples clustered into four different clades (Guillou *et al.*, 2004). However, the simple cellular traits of *Ostreococcus* do not allow morphological discrimination between different isolates (Chrétiennot-Dinet *et al.*, 1995). In the present paper, we examine the diversity in *Ostreococcus* by comparing 12 strains isolated from different marine ecosystems using three independent approaches: sequences of the rDNA internal transcribed spacer regions (ITS), pulsed-field gel electrophoresis (PFGE)

Received 14 September, 2004; accepted 2 November, 2004.
*For correspondence. E-mail h.moreau@obs-banyuls.fr; Tel. (+33) 468 887 309; Fax (+33) 468 887 398.

Table 1. Prasinophyceae strains used in this study.

Genus	RCC ^a	Isolate name	Geographic origin	Coordinates	Depth (m)	Clade	ITS-1/5.8S/ITS-2	GenBank
<i>Ostreococcus</i>	343	PROSOPE 5	Morocco Atlantic	30°8'N; 10°20'W	40	A	AY586747–49	
	344	PROSOPE 3	Morocco Atlantic	30°8'N; 10°20'W	5	A	AY586736–38	
	356	RA000412-9	English Channel	48°45'N; 3°57'W	0–5	A	AY586739–40	
	371	PROSOPE 44	Mediterranean Sea	36°29'N; 13°19'E	65	A	AY586734–35	
	420	RD010614-70-16	English Channel	48°45'N; 3°57'W	0–5	A	AY586744	
	141	EUM16BBL	Tropical Atlantic	21°2'N; 31°8'W	105	B	AY586730	
	143	EUM13B	Tropical Atlantic	21°2'N; 31°8'W	120	B	AY586731–33	
	393	PROSOPE 122-4	Mediterranean	41°54'N; 10°6'E	90	B	AY586741–43	
	410	REDSEA20-3	Red Sea	29°28'N; 34°55'E	100	B	AY586750–51	
	745	OTH95	Thau lagoon	43°24'N; 3°36'E	0–5	C	AY586729	
		OTH00 ^b	Thau lagoon	43°24'N; 3°36'E	0–5	C		
	501	BL 82-7	Mediterranean	41°40'N; 2°48'E	0–5	D	AY586745–46	
<i>Bathycoccus</i>	113	CCMP1898	Mediterranean	40°45'N; 14°20'E	Unknown			
<i>Micromonas</i>	434	BL 122	Mediterranean	41°40'N; 2°48'E	0–5			
<i>Micromonas</i>	658	CS-170	Western Australia	18–21°S; 116–119°30'E ^c	Unknown			

a. RCC corresponds to strain number in the Roscoff Culture Collection.

b. This strain has been lost and is not any more available in culture.

c. Coordinates of the Sola cruise SO 6/82 where the original strain was isolated.

that provides information on chromosomal structure and gene location, and pigment composition.

Results and discussion

Most of the studied *Ostreococcus* strains (Table 1) presented a distinct polymerase chain reaction restriction fragment length polymorphism (PCR-RFLP) profile for the ITS regions of the SSU ribosomal RNA operon. The relationships among the *Ostreococcus* strains were firmly resolved by ITS sequence phylogeny (Fig. 1) and supported the existence of the four *Ostreococcus* clades reported for SSU rRNA (Guillou *et al.*, 2004) despite the inclusion of five additional isolates. Clade A included strains isolated from surface down to 65 m depth. Clade B comprised strains isolated from the bottom of the euphotic zone (90–120 m). Finally, ITS sequences of OTH95 and RCC 501 (Mediterranean Sea, 0–5 m) constituted two independent clades, C and D respectively. Clade B displayed shorter ITS-1 length and lower G + C content in comparison with the other clades (Table 2). Sequence identity calculated on consensus sequences from clades A, B and D were 67%, 71% and 65% relative to the reference strain OTH95 (clade C).

Pulsed-field gel electrophoresis (PFGE) revealed variations in chromosome pattern among the *Ostreococcus* isolates. Still, all strains possessed an estimated chromosome number ranging from 15 to 20, regularly distributed between 0.15 and 1.5 Mbp (Fig. 2A). Such a chromosome length polymorphism has already been reported within natural populations of true species (Zolan, 1995) although karyotype stability is generally observed for mitotic organisms. Karyotype stability of *Ostreococcus* strains is confirmed in our results since the two strains OTH95 and OTH00 isolated at the same location in 1995 and 2000

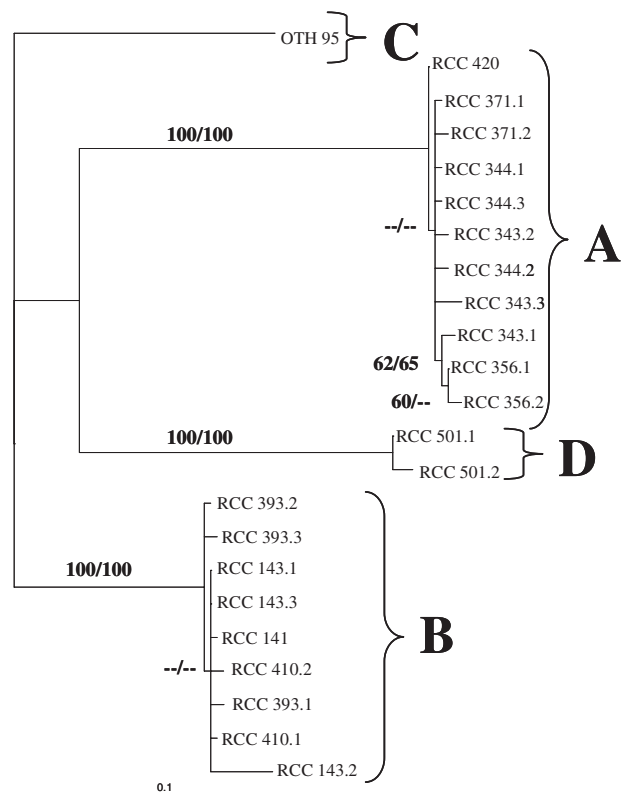
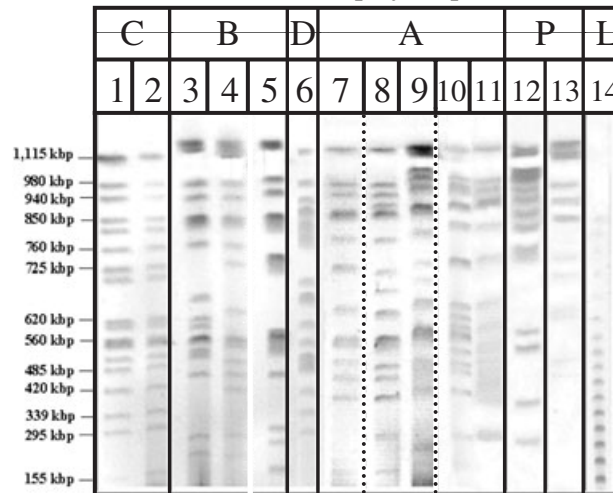
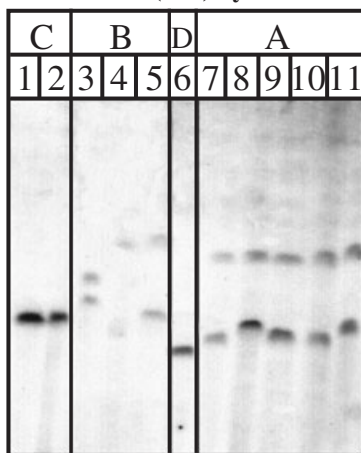
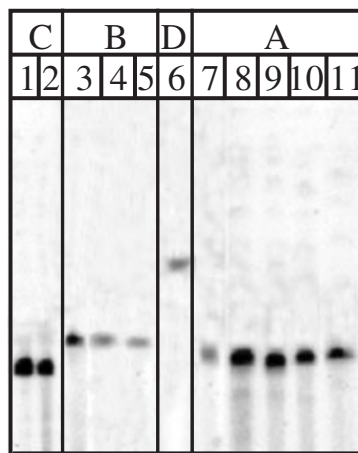
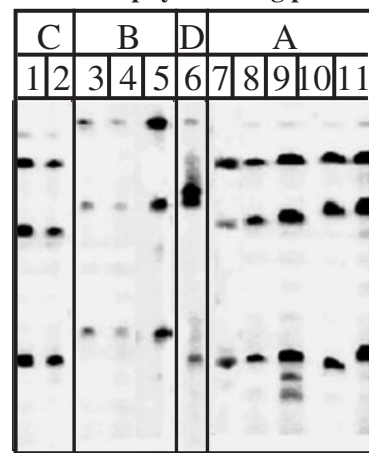

Fig. 1. Maximum likelihood phylogenies of 11 *Ostreococcus* strains (23 clones) inferred from the ITS-1 and ITS-2 regions of the ribosomal RNA operon. Similar topologies were obtained by Neighbour Joining. The phylogenetic tree shown was inferred by the Maximum Likelihood method based on a K80+G model¹³ with the following parameters: gamma distribution shape parameter = 0.4501, substitution model Ti/Tv ratio = 1.4476. Numbers placed next to the nodes are bootstrap values (1000 replicates) based on Maximum Likelihood/Maximum Parsimony respectively. Bootstrap values <60% are indicated by hyphens.

Table 2. Pigments (chl CS-170 and chl *b* ratios to chl *a*) and ITS characteristics (ITS-1 and ITS-2 length and percentage of G + C) in *Ostreococcus* strains.

<i>Ostreococcus</i> strains	Clade	Pigments		ITS-1		ITS-2	
		Chl CS-170	Chl <i>b</i>	ITS-1 length	ITS-1 GC%	ITS-2 length	ITS-2 GC%
RCC 343	A		0.648	155–156	53.7–56	255	57.6–58
RCC 344	A		0.680	153–155	55–55.8	255	57.6–58
RCC 356	A		0.622	153–155	53.7–54.4	255	57.6–57.2
RCC 371	A		0.664	155–156	54.6–55	255	57.6
RCC 420	A		0.613	155	54.4	255	57.6
RCC 141	B	0.021	0.967	143	48.9	264	54.9
RCC 143	B	0.019	0.846	143–148	46.7–48.9	264–265	54.5–55.3
RCC 393	B	0.010	1.011	139–142	48.5–49.3	264	54.1–55.3
RCC 410	B		0.916	142	48.5–49.3	264	54.5–54.9
OTH95	C		0.627	162	50.6	267	56.6
RCC 501	D		0.595	151–156	54–54.5	264–265	58.5–59.1

A PFGE chromosome polymorphism**B Ribosomal (28S) hybridization****C Actin****D Chlorophyll binding protein****Fig. 2.** Pulsed-field gel electrophoresis of *Ostreococcus* strains. (A) Ethidium bromide stained; or hybridized with: (B) a 28S rRNA probe; (C) an actin probe; or (D) a chlorophyll binding protein probe. A, B, C, D: *Ostreococcus* clades; P: other Prasinophyceae species; L: concatenated lambda phage genome. Lanes: (1) OTH95; (2) OTH00; (3) RCC 141; (4) RCC 143; (5) RCC 393; (6) RCC 501; (7) RCC 371; (8) RCC 343; (9) RCC 344; (10) RCC 356; (11) RCC 420; (12) RCC 113; (13) RCC 434.

respectively, shared identical chromosomal patterns (Fig. 2A, lanes 1 and 2). *Ostreococcus* strains belonging to clade B based on ITS and SSU rDNA sequences, possessed karyotypes with larger chromosomal bands compared to other *Ostreococcus* strains (Fig. 2A, lanes 3–5). Pulsed-field gel electrophoresis gels were then hybridized with three probes designed from the *O. tauri* OTH95 genome sequence (Derelle *et al.*, 2002): ribosomal RNA operon, actin and chlorophyll binding protein (CBP) (Fig. 2B–D). The actin gene is usually present as a single copy in algae (Bhattacharya and Medlin, 1998), whereas the two others are organized as repeated genes in one or several clusters (McGrath *et al.*, 1992; Prokopenko *et al.*, 2003). Hybridization patterns were identical for strains belonging to a given clade but different between the clades. The only exceptions were the hybridization signals obtained in clade B with the ribosomal RNA probe, which were different for each strain tested (Fig. 2B). Such high variability of the long tracts of rDNA has already been reported, even in highly stable genomes (Rustchenko *et al.*, 1993). The actin probe only labelled a single chromosome for each strain (Fig. 2C). In contrast, three chromosomes were hybridized by the CBP probe for the four clades with similar hybridization patterns for clades A and C (Fig. 2D).

Most isolates showed a common pigment composition with chlorophyll (chl) *b*, Mg 3,8 divinyl pheoporphyrin a_5 mono-methyl ester (MgDVP) and carotenoids from the prasinoxanthin and uriolide series (prasinoxanthin, uriolide and micromonal) (Fig. 3). Clade B strains exhibited higher chl *b* : chl *a* ratios (0.935 ± 0.071) than the rest of strains (0.636 ± 0.030) (Table 2). An additional chl *c*-like pigment was only present in RCC 141, 143 and 393, isolated from 90 and 120 m depth (Table 2 and Fig. 3). Its retention time and UV-VIS spectral properties were identical to those of a chl CS-170 standard isolated from *Micromonas pusilla*. This additional chl *c*-like pigment has been also found in other deep isolates of prasinophytes (Latasa *et al.*, 2005) suggesting its relationship with specific ecophysiological adaptations. Chl CS-170 could be synthesized from MgDVP (Porra *et al.*, 1997) and despite being in minor proportion, this chlorophyll probably plays a light-harvesting function in the blue-green region dominating at low ambient light level.

Growth rates were measured for different light intensities in six available clonal strains (two strains from clade A, two from clade B and one from clades C and D; Fig. 4). Only the strains from clades C and D were able to grow over the whole range of tested light intensities (5–800 $\mu\text{mol photon per m}^2$ per second) although clade B strains outperformed clade C and D strains at 5 and 20 $\mu\text{mol photon per m}^2$ per second. In contrast, strains from clade A were unable to grow below 20 $\mu\text{mol photons per m}^2$ per second and strains from clade B unable to grow

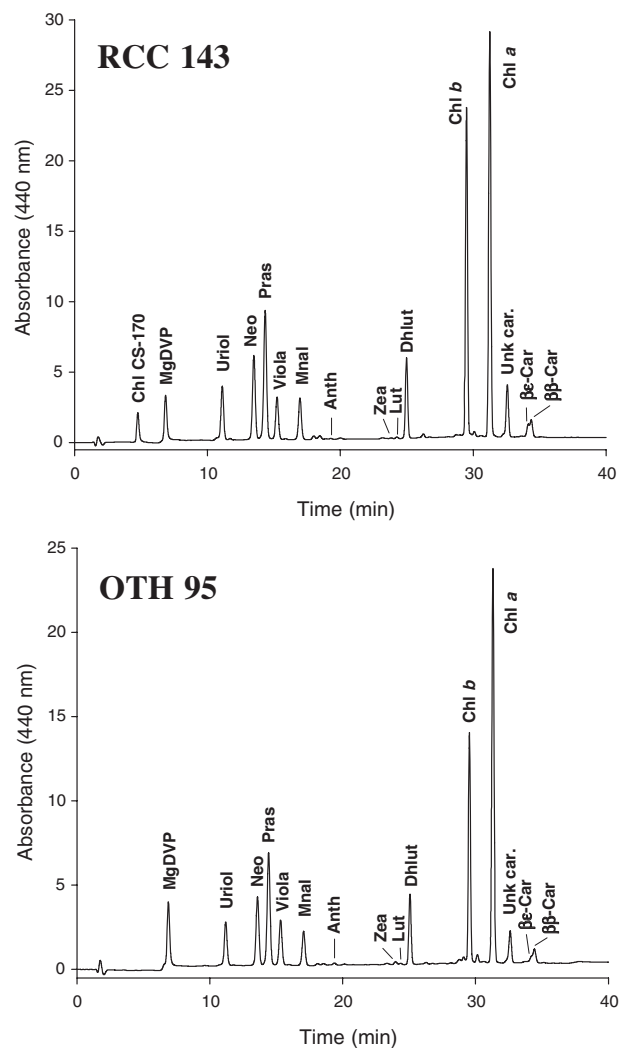

Fig. 3. High performance liquid chromatography analysis of *Ostreococcus* strains RCC 143 and OTH95. Carotenoid abbreviations code for the following pigments: Uriol (uriolide), Neo (neoxanthin), Pras (prasinoxanthin), Viola (violaxanthin), Mnal (micromonal), Anth (antheraxanthin), Zea (zeaxanthin), Lut (lutein), Dhlut (dihydroxylutein), Unk car (unknown carotenoid), β,ϵ -car (β,ϵ -carotene), β,β -car (β,β -carotene).

above 400. This contrasting growth behaviour between strains of clades A and B is strongly reminiscent of what has been established for the low-light and high-light *Prochlorococcus* ecotypes (Moore *et al.*, 1998; Moore and Chisholm, 1999).

Genetic distances between isolates do not reflect geographical trends as shown by the diverse origins of the *Ostreococcus* strains grouped in clades A/C/D and B. Rather, light and nutrient conditions experienced by surface and deep isolates could be the driving factors behind their genetic divergence. The higher chl *b* : chl *a* ratios and the photo-inhibition of the growth rate observed in clade B point to an adaptation of the photosynthetic apparatus

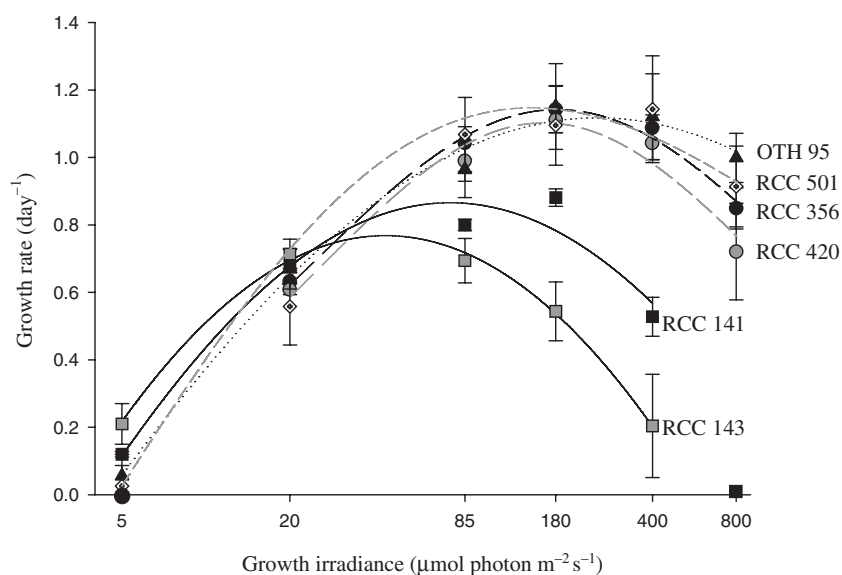

Fig. 4. Growth rate of surface and deep *Ostreococcus* strains as a function of light intensity. Clade A strains: RCC 356 and 420; clade B strains: RCC 141 and 143; clade C strain: OTH95; clade D strain RCC 501. RCC 141 and 143 (clade B) did not grow at 800 $\mu\text{mol photon m}^{-2}$ per second, while RCC 356 and 420 (clade A) did not grow at 5 $\mu\text{mol photon m}^{-2}$ per second. Error bars correspond to standard error of three replicate experiments. Light intensity axis (X) is logarithmic while the cell growth rate axis (Y) is linear.

in clade B *Ostreococcus* to maximize light-harvesting and growth efficiencies under the low light conditions prevailing at depth. In conclusion, phylogenetic and physiological data presented in this study suggest that the concept of ecotype previously applied to marine cyanobacteria (Moore *et al.*, 1998) could also be valid for eukaryotes. Although the diversity of picoeukaryotes is high and probably still far to be entirely explored, recent molecular studies suggest that a few species dominate the photosynthetic picoeukaryotic assemblages in specific oceanographic regions (Vaulot *et al.*, 2002). These dominating species mainly belong to Prasinophyceae and the existence of genetically heterogeneous populations (i.e. different ecotypes), demonstrated here for *Ostreococcus*, would contribute to explain the diverse ecological niches exploited by this limited number of picoeukaryote species.

Experimental procedures

Cultures and isolation of DNA

Twelve picoeukaryote strains with cell morphology similar to *O. tauri* (reference strain OTH95) were used in this study (Table 1). Three additional Prasinophyceae strains were also included for comparison purposes. Clonal strains were obtained from agar plated cultures and isolated colonies were grown in liquid for further study. All cultures were maintained in K medium (Keller *et al.*, 1987) under a 12:12 light:dark cycle. Cultures for growth experiments were kept at $22 \pm 1^\circ\text{C}$, from 5 to 800 $\mu\text{mol photon m}^{-2}$ per second of irradiance, while those used for pigment analysis were grown at $19 \pm 1^\circ\text{C}$ and 30 $\mu\text{mol photon m}^{-2}$ per second.

Growth rate measurements

Cultures (50 ml volume) acclimated at 5–20 $\mu\text{mol photons m}^{-2}$ per second were transferred gradually to increasing

irradiance until observing growth in the whole light range (whenever possible) and later grown at each light intensity during at least three generations prior to experiments. Light irradiance was measured in water with a LICOR (LI-1000) quantummeter equipped with a spherical probe (LI-COR SPQA). Growth rates were then determined in three distinct consecutive experiments by sampling each culture at the same time of the day using a flow cytometer (FACSort, Becton Dickinson). Growth rates were calculated as the slope of an $\text{Ln}(N_t)$ versus time plot where N_t is cell number at time t .

DNA amplification and sequencing

Extracted DNA was used as a template to amplify ITS-1, 5.8S rRNA and ITS-2. Internal transcribed spacers and 5.8S rRNA were amplified and cloned using a forward primer (EUK 328f) near the 3' end of the 18S rRNA gene of *O. tauri* OTH95 and a reverse primer in the 28S rRNA gene (329r) as described in Guillou and colleagues (2004). The length of the ITS-1 and ITS-2 sequences varied from 139 to 162 bp and from 256 to 268 bp respectively. In comparison, *M. pusilla* (RCC 450) showed ITS-1 and ITS-2 sequences of 152 bp and 239 bp length, with a 48% of sequence similarity relative to OTH95. Polymerase chain reaction products from at least 20 clones of each *Ostreococcus* strain were analysed by RFLP to assess genetic polymorphism. ITS-1, 5.8S rRNA and ITS-2 sequences are deposited in GenBank (Table 1).

Phylogenetic analyses

Sequences of different *Ostreococcus* strains were compared using three different phylogenetic analyses (maximum parsimony, MP; neighbour joining, NJ; and maximum likelihood, ML). Different nested models of DNA substitution and associated parameters were estimated using Modeltest 3.0 (Posada and Crandall, 1998). These parameters were used to process the NJ and ML using the PAUP*4.0b10 version. Weighted MP was inferred using the heuristic search procedure with the tree-bisection–reconnection branch swapping

algorithm. Bootstrap values were assessed from 1000 replicates.

Pulsed-field gel electrophoresis (PFGE)

From 2×10^7 to 5×10^7 *O. tauri* cells embedded in agarose were loaded per lane in a 0.8% agarose gel (chromosomal grade). The PFGE parameters were 3 V cm⁻¹, 0.5× TBE (Tris-borate 89 mM, EDTA 2 mM buffer), 120° switching angle, 14°C, 90 s switch time for 45 h then 140 s switch time for 27 h. After denaturation, the gel was dried and directly hybridized with the radioactive probes (Mead *et al.*, 1988). DNA fragments of about 500 bp were used as probes. These fragments were amplified by standard PCR, using specific primers designed from gene sequences identified from the *O. tauri* complete genome sequencing project. Sequences of these primers were: (i) actin 5'-AACTGGGACGACATG GAGAA-3' and 5'-GCGACAACCTTGATCTTCAT-3', (ii) 28S ribosomal gene 5'-ACCCGCTGAATTTAAGCATA-3' and 5'-CCTTGGTCCGTGTTTCAAGA-3' and (iii) CBP 5'-TTCGAG GTCACCAGACTCGG-3' and 5'-ATCGAGCAATCGTTTAC GTC-3'. DNA probes were labelled with [α -³²P]-dCTP by random priming.

Pigment analyses

Analytical and semipreparative high-performance liquid chromatograph (HPLC) separations followed a protocol adapted from that of Zapata and colleagues (2000). For further matching of a chlorophyll (chl) *c*-like pigment isolated from RCC 393 against chl CS-170, *M. pusilla* (CS-170) was purchased from CSIRO Culture Collection (Hobart, Tasmania). Chlorophylls and carotenoids were detected by absorbance at 440 nm and identified by diode array spectroscopy (Jeffrey *et al.*, 1997). *Ostreococcus* pigments were identified by cochromatography with authentic standards (Sigma-Aldrich) and those from extracts of *M. pusilla* (RCC 450 and 658).

Acknowledgements

We thank A. Worden for critically reading earlier versions of this manuscript, N. Simon and N. West for practical help, C. Courties for providing the strain OTH95 and for his help in isolating the strain OTH00. This work was supported by the EU project PICODIV (EVK3-CT-1999-00021). F.R. was supported by an Alfonso Martin Escudero postdoctoral fellowship.

References

Andersen, R.A., Bidigare, R.R., Keller, M.D., and Latasa, M. (1996) A comparison of HPLC pigment signatures and electron microscopic observations for oligotrophic waters of the North Atlantic and Pacific Oceans. *Deep-Sea Res Pt II* **43**: 517–537.

Bhattacharya, D., and Medlin, L. (1998) Algal phylogeny and the origin of land plants. *Plant Physiol* **116**: 9–15.

Campbell, L., Nolla, H.A., and Vaultot, D. (1994) The importance of *Prochlorococcus* to community structure in the central North Pacific Ocean. *Limnol Oceanogr* **39**: 954–961.

Chrétiennot-Dinet, M.J., Courties, C., Vaquer, A., Neveux, J.,

Claustre, H., Lautier, J., *et al.* (1995) A new marine picoeukaryote: *Ostreococcus tauri* gen. et sp. nov. (Chlorophyta, Prasinophyceae). *Phycologia* **4**: 285–292.

Courties, C., Vaquer, A., Troussellier, M., Lautier, J., Chrétiennot-Dinet, M.J., Neveux, J., *et al.* (1994) Smallest eukaryotic organism. *Nature* **370**: 255.

Derelle, E., Ferraz, C., Lagoda, P., Eychenié, S., Cooke, R., Regad, F., *et al.* (2002) DNA libraries for sequencing the genome of *Ostreococcus tauri* (Chlorophyta, Prasinophyceae): the smallest free-living eukaryotic cell. *J Phycol* **38**: 1–8.

Díez, B., Pedrós-Alió, C., Marsh, T.L., and Massana, R. (2001) Application of denaturing gradient gel electrophoresis (DGGE) to study the diversity of marine picoeukaryotic assemblages and comparison of DGGE with other molecular techniques. *Appl Env Microb* **67**: 2942–2951.

Guillou, L., Eikrem, W., Chrétiennot-Dinet, M.J., Le Gall, F., Massana, R., Romari, K., *et al.* (2004) Diversity of picoplanktonic Prasinophyceae assessed by direct SSU rDNA sequencing of environmental samples and novel isolates retrieved from oceanic and coastal marine ecosystems. *Protist* **155**: 193–214.

Jeffrey, S.W., Mantoura, R.F.C., and Bjørnland, T. (1997) Chlorophyll and carotenoid extinction coefficients. In *Phytoplankton Pigments in Oceanography: Guidelines to Modern Methods*. Jeffrey, S.W., Mantoura, R.F.C., and Wright, S.W. (eds). Paris, France: UNESCO, pp. 595–596.

Keller, M.D., Selvin, R.C., Claus, W., and Guillard, R.R.L. (1987) Media for the culture of oceanic ultraphytoplankton. *J Phycol* **23**: 633–638.

Latasa, M., Scharek, R., Le Gall, F., and Guillou, L. (2005) Pigment suites and taxonomic groups in Prasinophyceae. *J Phycol* (in press).

Li, W.K.W. (1994) Primary productivity of prochlorophytes, cyanobacteria, and eucaryotic ultraphytoplankton: measurements from flow cytometric sorting. *Limnol Oceanogr* **39**: 169–175.

McGrath, J.M., Terzaghi, W.B., Sridhar, P., Cashmore, A.R., and Pichersky, E. (1992) Sequence of the 4th and 5th photosystem-II type-I chlorophyll *a/b*-binding protein genes of *Arabidopsis thaliana* and evidence for the presence of a full complement of the extended CAB gene family. *Plant Mol Biol* **19**: 725–733.

Mead, J.R., Arrowood, M.J., Current, W.L., and Sterling, C.R. (1988) Field inversion gel electrophoretic separation of *Cryptosporidium* spp. Chromosome-sized DNA. *J Parasitol* **74**: 366–369.

Moore, L.R., and Chisholm, S.W. (1999) Photophysiology of the marine cyanobacterium *Prochlorococcus*: ecotypic differences among cultured isolates. *Limnol Oceanogr* **44**: 628–638.

Moore, L.R., Rocab, G., and Chisholm, S.W. (1998) Physiology and molecular phylogeny of coexisting *Prochlorococcus* ecotypes. *Nature* **393**: 464–467.

Partensky, F., Hess, W.R., and Vaultot, D. (1999) *Prochlorococcus*, a marine photosynthetic prokaryote of global significance. *Microb Molec Biol Rev* **63**: 106–127.

Porra, R.J., Pfündel, E.E., and Engel, N. (1997) *Phytoplankton Pigments in Oceanography: Guidelines to Modern Methods*. Jeffrey, S.W., Mantoura, R.F.C., and Wright, S.W. (eds). Paris, France: UNESCO, pp. 85–126.

- Posada, D., and Crandall, K.A. (1998) Modeltest: testing the model of DNA substitution. *Bioinformatics* **14**: 817–818.
- Prokopowich, C.D., Gregory, R.R., and Crease, T.J. (2003) The correlation between rDNA copy number and genome size in eukaryotes. *Genome* **46**: 48–50.
- Rocap, G., Distel, D.L., Waterbury, J.B., and Chisholm, S.W. (2002) Resolution of *Prochlorococcus* and *Synechococcus* ecotypes by using 16S–23S ribosomal DNA internal transcribed spacer sequences. *Appl Environ Microbiol* **68**: 1180–1191.
- Rocap, G., Larimer, F.W., Lamerdin, J., Malfatti, S., Chain, P., Ahlgren, N.A., *et al.* (2003) Genome divergence in two *Prochlorococcus* ecotypes reflects niche differentiation. *Nature* **424**: 1042–1046.
- Rustchenko, E.P., Curran, T.M., and Sherman, F. (1993) Variations in the number of ribosomal DNA units in morphological mutants and normal strains of *Candida albicans* and in normal strains of *Saccharomyces cerevisiae*. *J Bacteriol* **175**: 7189–7199.
- Sym, S.D., and Pienaar, R.N. (1993) The class Prasinophyceae. *Prog Phycol Res* **9**: 281–376.
- Vaulot, D., Romari, K., and Not, F. (2002) Are autotrophs less diverse than heterotrophs in marine picoplankton? *Trends Microbiol* **10**: 266–267.
- Worden, A.Z., Nolan, J.K., and Palenik, B. (2004) Assessing the dynamics and ecology of marine picophytoplankton: the importance of the eukaryotic component. *Limnol Oceanogr* **49**: 168–179.
- Zapata, M., Rodríguez, F., and Garrido, J.L. (2000) Separation of chlorophylls and carotenoids from marine phytoplankton: a new HPLC method using a reversed phase C₈ column and pyridine-containing mobile phases. *Mar Ecol Prog Ser* **195**: 29–45.
- Zolan, M.E. (1995) Chromosome-length polymorphism in fungi. *Microbiol Rev* **59**: 686–698.